

Panasonic
ideas for life



Slim Plastic Type //

Cabinet Fan

Slim Plastic Type Cabinet Fan

Panasonic new slim plastic type cabinet fan can be perfectly integrated in the duct works. This fan can be used as single port or multi port to exhaust air from several areas with only one unit and your choice for ideal ventilating system in providing excellent Indoor Air Quality (IAQ).



Compact size

- slim and compact design allows easy installation at narrow ceiling space
- compared with existing models, new plastic slim type reduces size of height in 33%

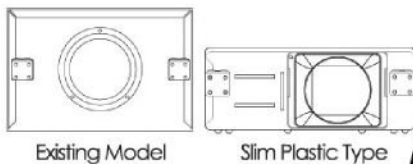

Existing Model

Slim Plastic Type

High static pressure

- special design blade and airflow allows achieving high static pressure in slim and compact casing



High air volume, low noise level

- newly design airflow in slim casing not only provide high air volume but also keep in low operating noise level

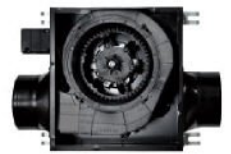

Two speed selection

- high and low notch can be chosen to enhance the scope of application and increase the flexibility of ventilation system planning

Easy installation

- u-grooved mounting brackets prevents the loosen of mounting bolts. It reinforces the installation safety
- attached round-shape adaptor can be removed to facilitate your square-shape duct work installation



Parts Name And Dimensions

Remark : the views are 3rd angle.

No.	Part name	Q'ty	No.	Part name	Q'ty
①	Adapter	2	⑥	Blade	1
②	Hanger fitting	4	⑦	Fan casing	1
③	Inspection panel	1	⑧	Wiring box cover	1
④	Casing assy	1	⑨	Orifice	1
⑤	Motor	1			

Unit: mm

Model	A	B	C	D	E	F	G	H	I	J	Connector Duct Dimension
FV-02NU1H	315	281	107	98	285	85	330	455	120	92	Φ100
FV-04NU1H	315	281	118	148	285	100	330	485	170	107	Φ150
FV-05NU1H	362	327	119	148	338	100	383	538	170	107	Φ150
FV-07NU1H	362	327	119	148	338	100	383	538	170	107	Φ150

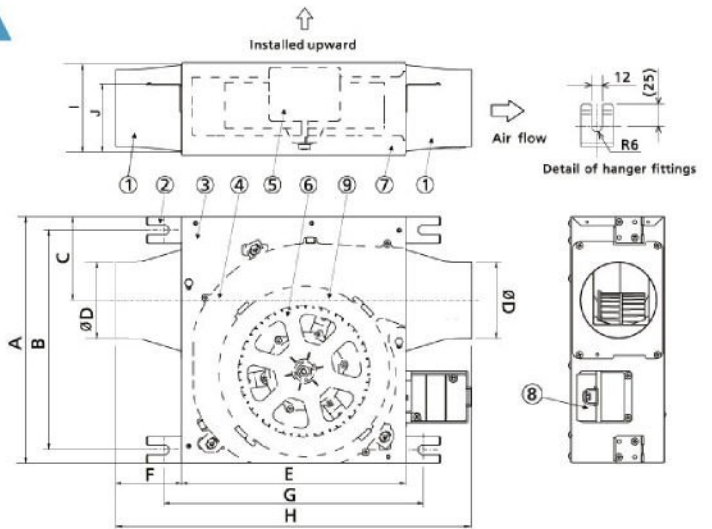

Air Volume

Static Pressure Curve

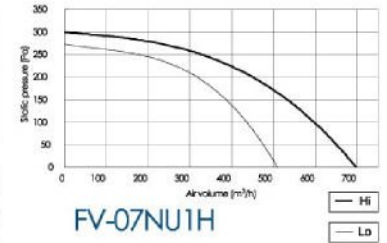
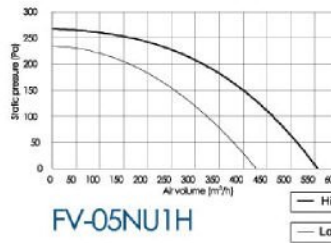
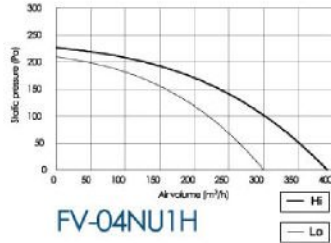
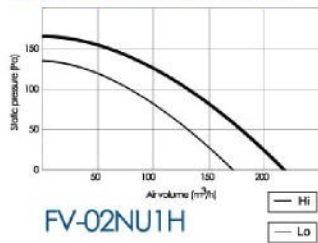

Specification

Model No.	Air Volume (CMH)				Noise (dB)	Power (W)	Dimension (mm)			Duct Diameter (mm)	Net Weight (kg)
	0 Pa	100 Pa	150 Pa	200 Pa			H	L	W		
FV-02NU1H	218	130			24	27	120	285	315	Φ100	3.8
FV-04NU1H	392	300			31	62	170	285	315	Φ150	4.4
FV-05NU1H	554		400		34	83	170	338	362	Φ150	6.4
FV-07NU1H	694			450	37	118	170	338	362	Φ150	8.3

Wiring Diagram

High Notch

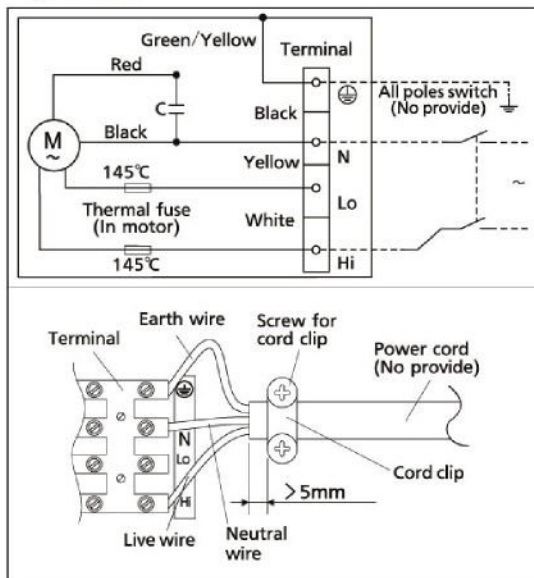

Low Notch

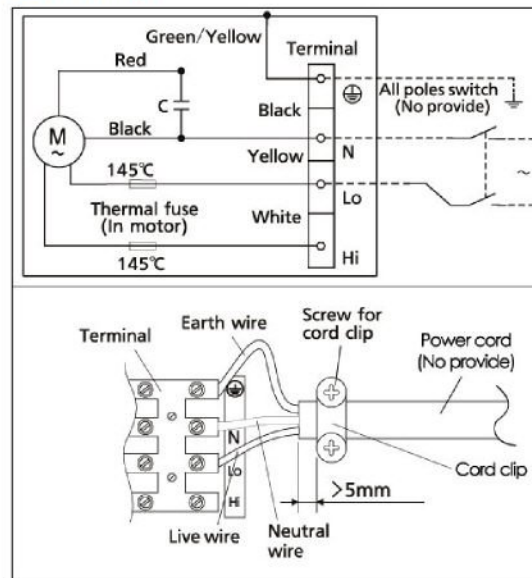

Panasonic

ideas for life



總代理 Sole Agent

信興電工工程有限公司
SHUN HING ELECTRIC WORKS AND ENGINEERING CO., LTD.

辦公室 Office 香港九龍尖沙咀東部加連威老道98號東海商業中心601室
Room 601, East Ocean Centre, 6/F., 98 Granville Road,
Tsimshatsui East, Kowloon, Hong Kong

電話 Tel (852) 2861 2767

傳真 Fax (852) 2865 6706

網址 Website www.shew.com.hk

電郵 E-mail shew@shunhinggroup.com

保養及維修 Maintenance and Repair Service

信興電器服務中心有限公司
SHUN HING ELECTRIC SERVICE CENTRE LTD.

辦公室 Office 香港新界葵涌葵興街8號信興中心19樓
19th Floor, Shun Hing Centre, 8 Shing Yiu Street,
Kwai Chung, New Territories, Hong Kong

電話 Tel (852) 2406 5666

傳真 Fax (852) 2408 0316

網址 Website www.shunhing-service.com